



advantis

console

scanmagnetics.com

 **Gesab**
guarantee for the future

WHAT IS ADVANTIS?



“It is a new concept in Control Consoles designed to organise highly technical work spaces, where image, quality and comfort are vitally important.



advantis
console

ADVANTIS' KEY FEATURES



1. LAYOUT:

A program of superior quality designed to organise technical work spaces. It has a wide range of configurations and finishes.

2. ERGONOMICS:

An organisation system which can adapt to the needs of the operator and the computer systems that s/he controls.

3. CONNECTIVITY:

A design which simplifies connection to electricity and data sources and manages all cabling in keeping it well ordered and out of sight.

advantis
console



ADVANTIS' KEY FEATURES



4. DESIGN AND QUALITY:

4.1-High quality materials are used in both the work surfaces and structure.

4.2-The product is highly adaptable and allows the user to personalise it according to their specific requirements.

5. GUARANTEE

All of the ADVANTIS components are designed to last, they therefore carry a 10 year guarantee.

advantis
console

WORKSPACES



1. Command & Contact centres.
2. Control Rooms.
3. Advanced Call Centres.
4. Stock Exchange Offices.
5. Conference Rooms.
6. Management Offices.
7. Corporate Reception Areas.
8. Organisation of Superior Quality Workspaces.



advantis
console

scanmagnetics.com

INDUSTRIAL SECTORS

1. Energy: Electricity, Oil, Gas.
2. Water/ Gas Supply.
3. Telecommunications.
4. Aeronautics / Aerospace.
5. Transport: Rail, Air and Road Networks.
6. Official Organisations.
7. Security Installations.
8. Offices Supplies.
9. Finance and Credit.
10. Audiovisual.
11. Information Technology.

TYPES OF CONFIGURATON

1-Linear:

- 1200mm Structures
- 1600mm Structures
- 2000mm Structures

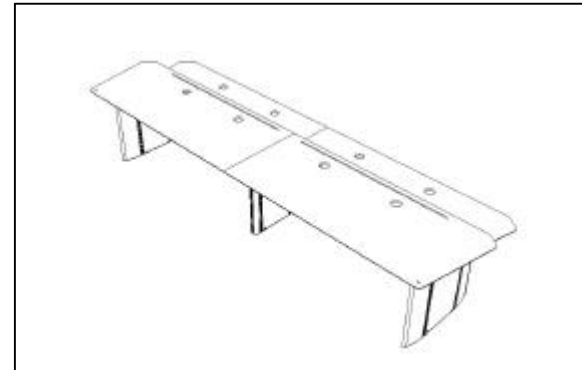

2-Curved:

- 15 ° / 30° / 45° / 60° / 90°

All configurations are available as concave or convex formations.

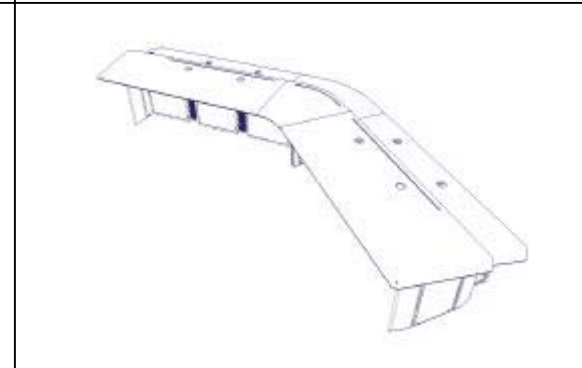

3-Mixed:

Linear and curved configurations can be achieved using intercalating sections.



MAIN FORMATS

1-Desk Level

- One single worksurface.
- Maximum simplicity.
- Linear and curved configurations.
- Cabinets can be incorporated.

2-Low Level

- 2 worksurfaces at different levels.
- Electrical and data connections at low level.
- Cabinets can be incorporated at low level.
- Linear and curved configurations.

3-High Level

- 3 worksurfaces at different levels.
- Electrical and data connections at all levels.
- Cabinets can be incorporated at low level.
- Linear and curved configurations



advantys
console

Gesab®
guarantee for the future

BASIC MEASUREMENTS

SIDE VIEW

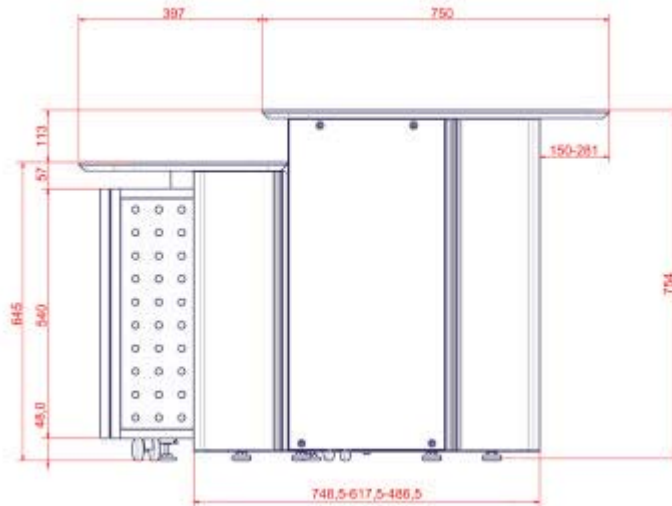

Desk Level / Low Level

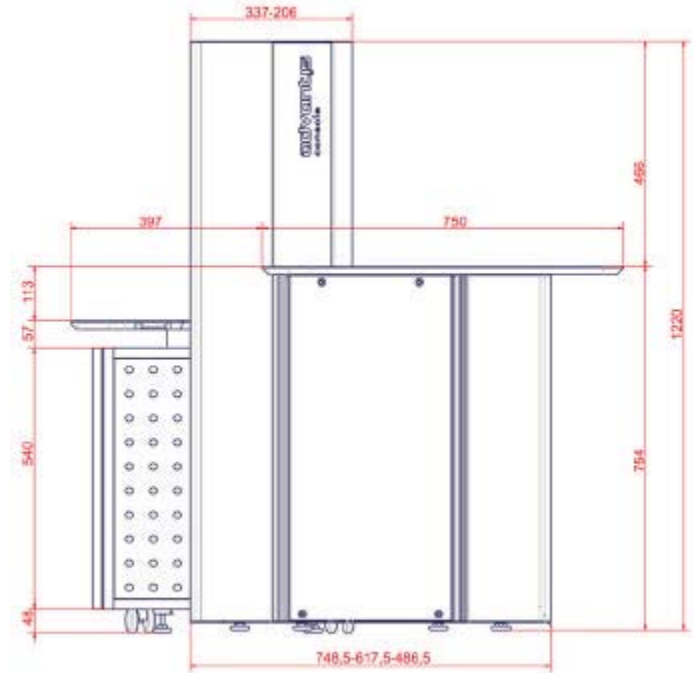

High Level

Note:

*Structural sections are available 1200mm, 1600mm and 2000mm wide.

*Linear and curved configurations set at 15°,30°,45°,60° and 90° can be created.

advantis
console

CORE ELEMENTS

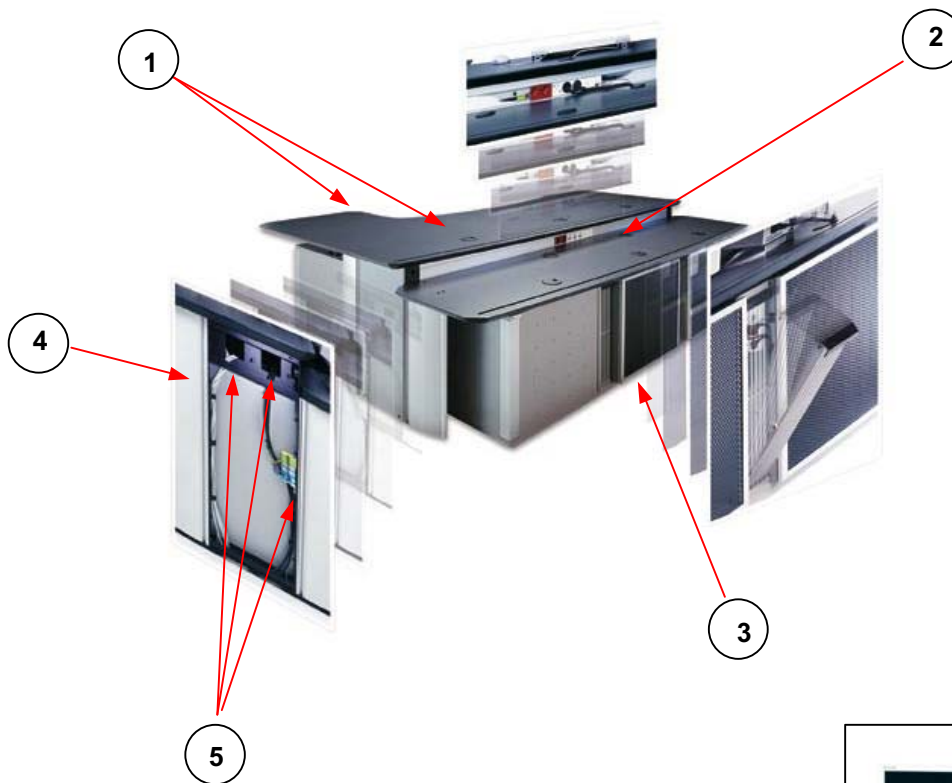

1-Work Surfaces.

2-Surface Connections.

3-Enclosed Cabinets.

4-Uprights.

**5-Electrical Connection and
Cable Management.**

6-Monitor Arms

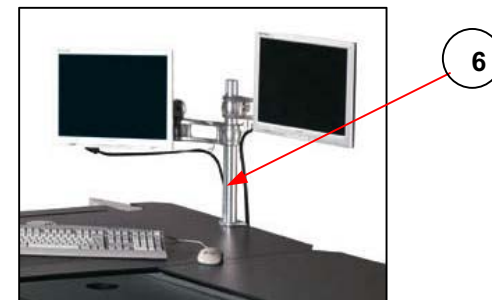

advantix
console

CORE ELEMENTS

1-STANDARD WORK SURFACES

Material: 18mm Compact Laminate



Beech



Dark Grey



Light Grey

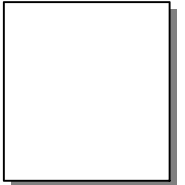

White

COLOUR COMBINATIONS:

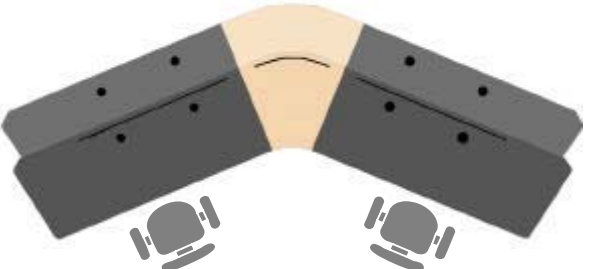
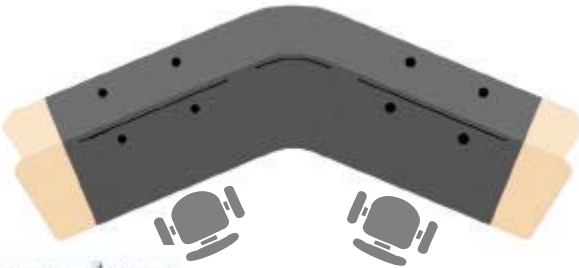
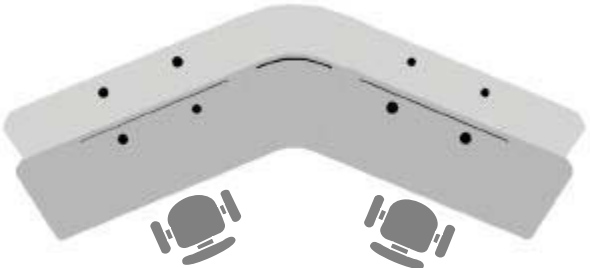
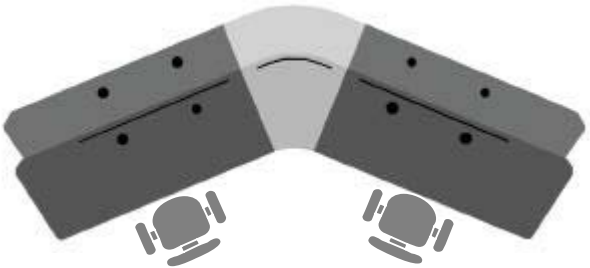

advantys
console

CORE ELEMENTS

1.1-SPECIAL ORDER WORK SURFACES

1. **ADVANTIS** work surfaces can be personalised on request.
2. A colour chart with over 90 different colours is available for customers to chose from.
3. Other materials can be used such as laquered DM, Silestone, Corian, etc...



DuPont™
CORIAN®  *The miracles of science™*

SILESTONE®
by COSENTINO

advantis
console

 **Gesab**®
guarantee for the future

CORE ELEMENTS

2-LOW LEVEL SURFACE CONNECTIONS



1. ADVANTIS incorporates surface connections to facilitate the connection of all equipment positioned on the rear shelving of the console to electricity and data.
2. 45x45 universal connectors can be fitted to the console.

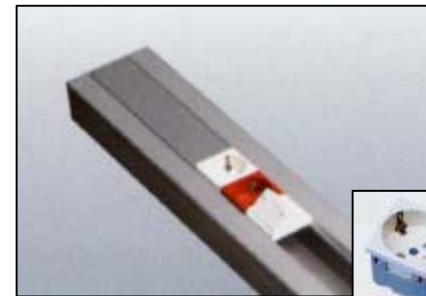

advantis
console

scanmagnetics.com

CORE ELEMENTS

2.1-HIGH LEVEL SURFACE CONNECTIONS



1. ADVANTIS consoles can incorporate connections on its upright components, thus facilitating the connection of equipment positioned away from standard data or electrical points.
 - Any universal 45x45 connectors can be connected to the console.

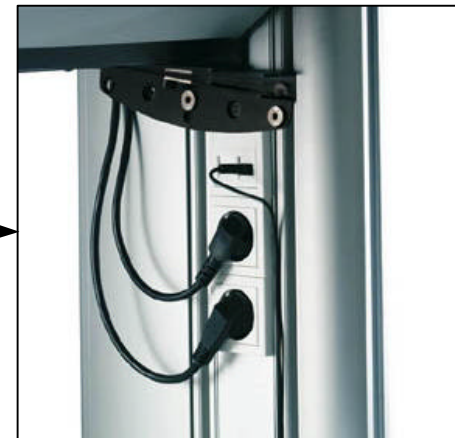

CORE ELEMENTS

3-ENCLOSED CABINETS

1. The cabinets are designed to house tower or 19" equipment installations.
2. The natural position in which to install them is under the rear shelving, allowing them to also be used as mobile units, independent of the console itself.

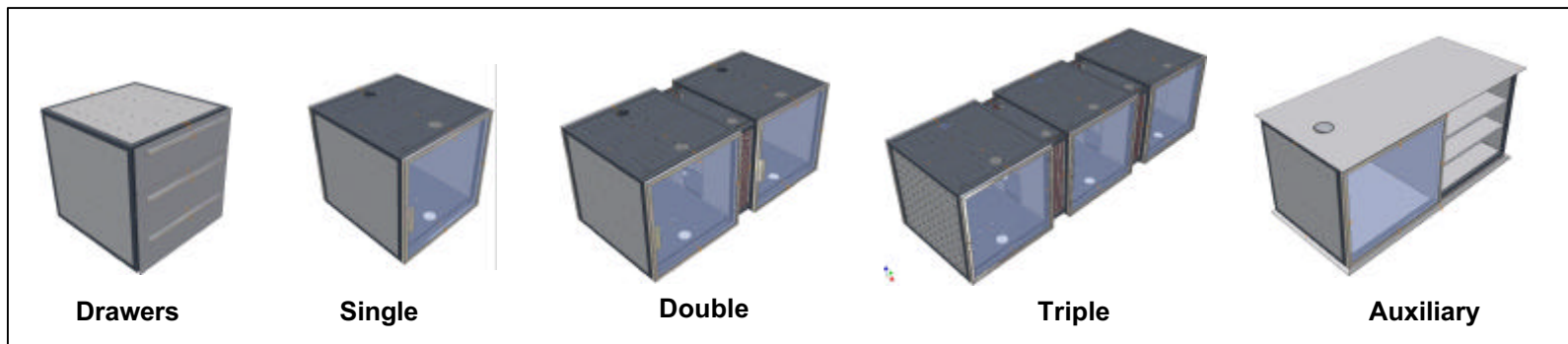

CORE ELEMENTS

3.1-ENCLOSED CABINETS (CONSTRUCTION)

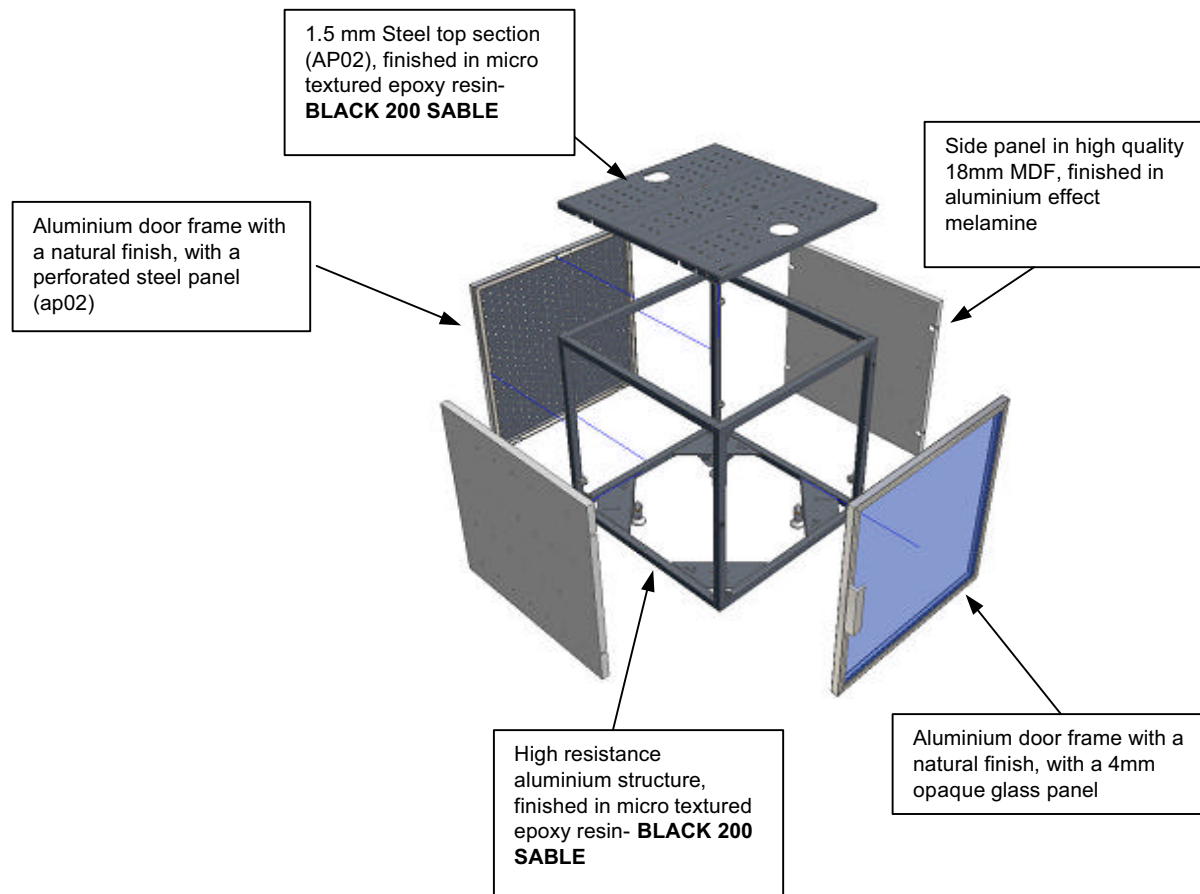

CORE ELEMENTS

3.2-ENCLOSED CABINETS : Technical Service Area

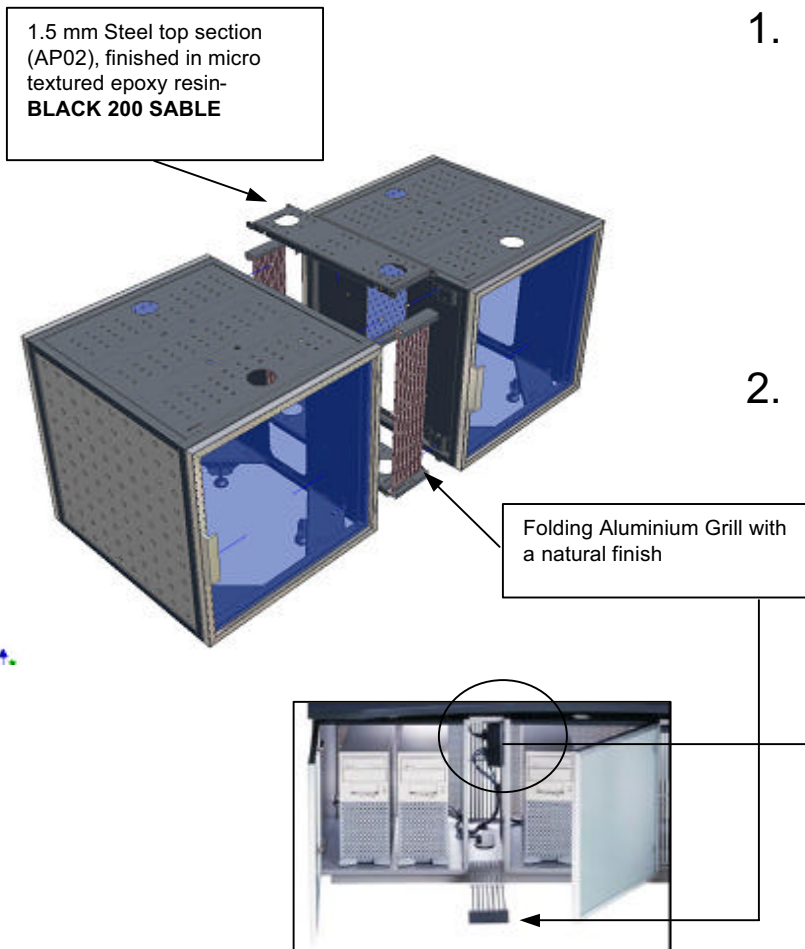

1. The T.S.A. is the zone between the lockable cabinets, designed to house the necessary adaptors or connectors to allow the console to be connected to external power and data services.
2. The T.S.A. is accesible via the folding aluminium grill for ease of access.



CORE ELEMENTS

4- ADVANTIS UPRIGHTS



1-LOW LEVEL UPRIGHT



2-CONFERENCE DESK UPRIGHT



3-HIGH LEVEL UPRIGHT

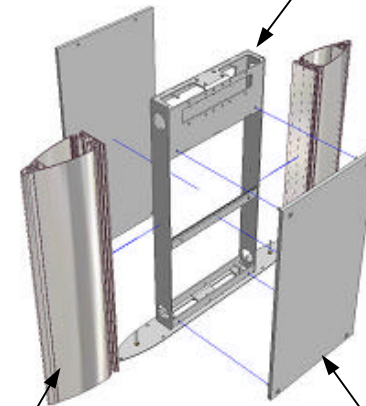

4mm sheet steel (AP02),
finished in micro textured
epoxy resin **BLACK 200**
SABLE

High resistance
aluminium end sections,
finished in micro textured
epoxy resin **GREY 150**
SABLE

10 mm high quality MDF
finished with a matt effect
aluminium melamine.
On request these side
panels can be supplied in
other materials as long as
they can be obtained in
the appropriate 10mm
thickness.



CORE ELEMENTS

5-ELECTRICAL CONNECTION AND CABLE MANAGEMENT

1. Connection points are incorporated into the upright sections so that power can be distributed via the horizontal channels.
2. All cabling is connected to the worksurfaces and the rear cabinets.

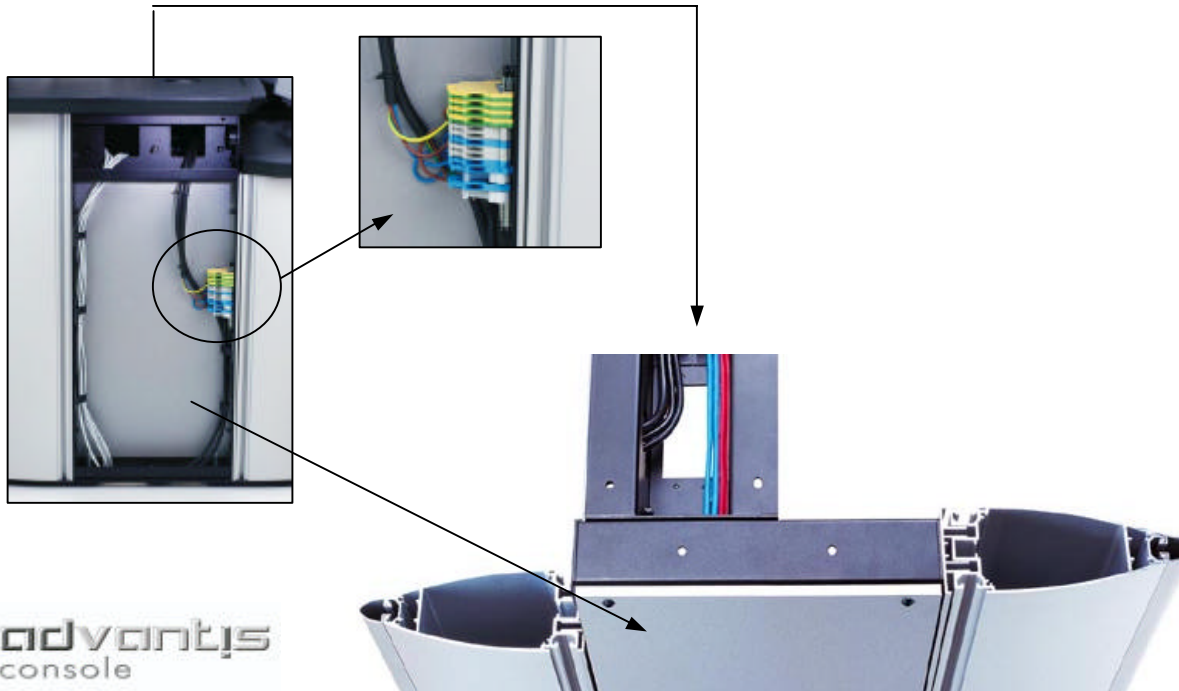
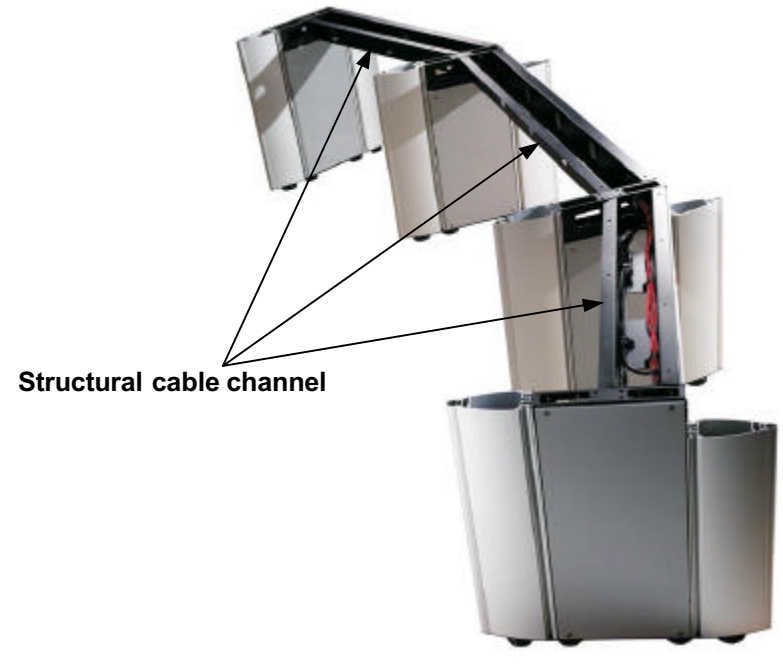

CORE ELEMENTS

6- Flat Screen Monitor Arms



Single Monitor Arm



Double Monitor Arm

Available Finishes



Matt Aluminium

Graphite

Polished Aluminium



CORE ELEMENTS

6.1- Flat Screen Monitor Arms. (Configurations)

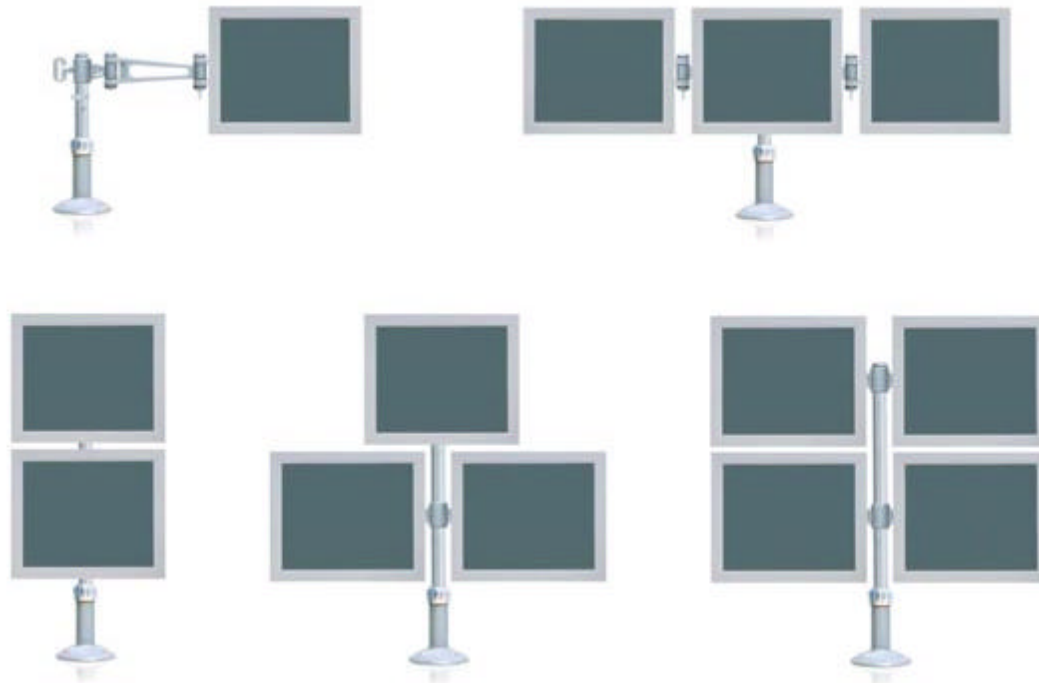

CONFIGURATION TYPES



advantis console



scanmagnetics.com

LOW LEVEL CONSOLE

advantis
console



1. Linear configurations with 1200, 1600 and 2000mm sections
2. Curved configurations, both convex and concave available with 15,30,45,60 and 90 degree angles.
3. Cabinets can be incorporated in the rear zone of the console.

HIGH LEVEL CONSOLE

advantis
console



Available in linear and curved configurations.

Upper level aluminium shelving.
Electrical and data points can be incorporated at all levels.

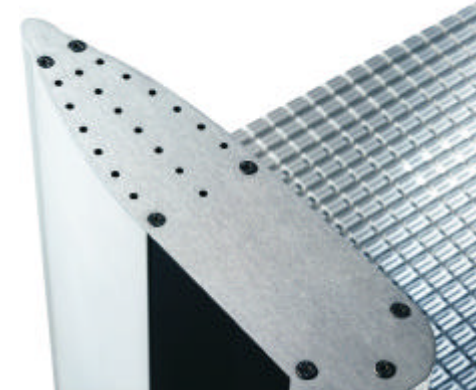

MANAGEMENT CONSOLE

advantis
console



1. Available in a large range of configurations.
2. All of the cabinets installed are interconnected, guaranteeing well ordered and out of sight cabling.



TOTEM CONSOLE

advantis
console

1. Designed to create monitoring panels, positioned in front of control consoles.
2. Utilizes the same structural elements and finishes as all other consoles.



CONFERENCE CONSOLES

advantis
console



1. The desktop is available in 15mm glass or 18mm compact laminate
2. Electrical and data points are incorporated at desk level

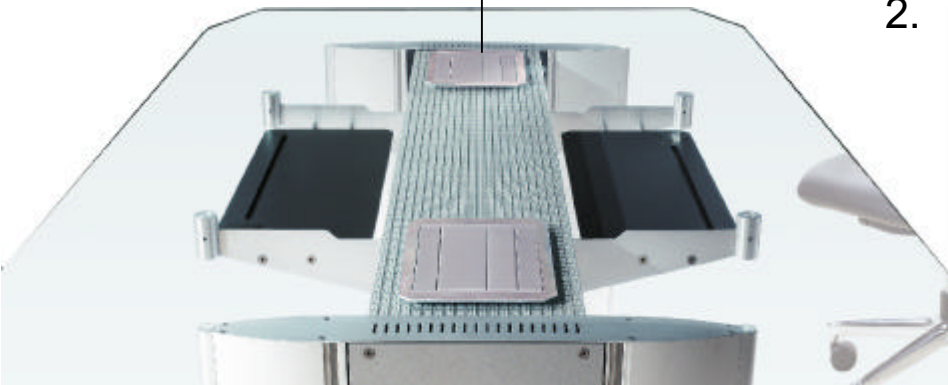

SAMPLE PROJECTS

advantis
console

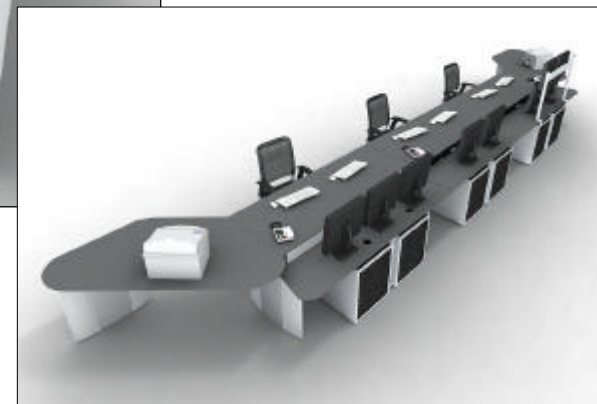

SAMPLE PROJECTS

advantis
console

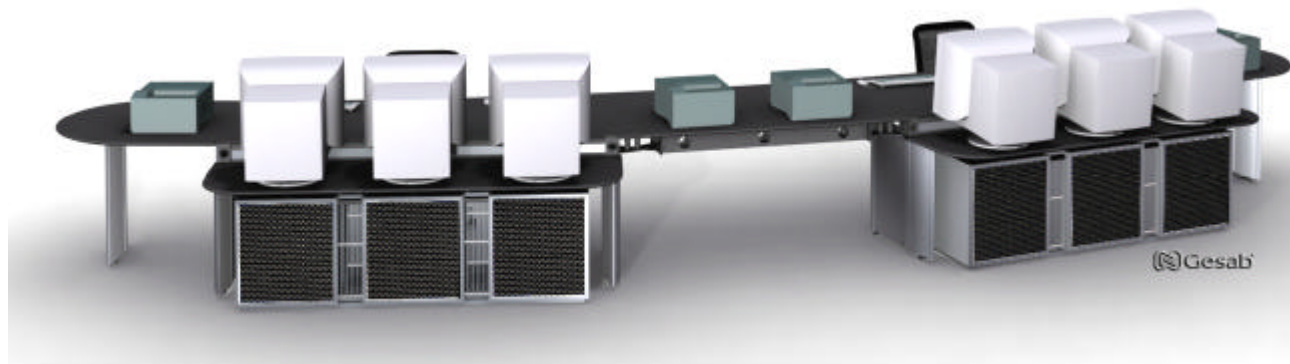

SAMPLE PROJECTS

advantis
console

BI GRUPO BESTINVER



SAMPLE PROJECTS

advantis
console



CONFERENCES

advantix
console

ADVANCED CONSOLE SOLUTIONS

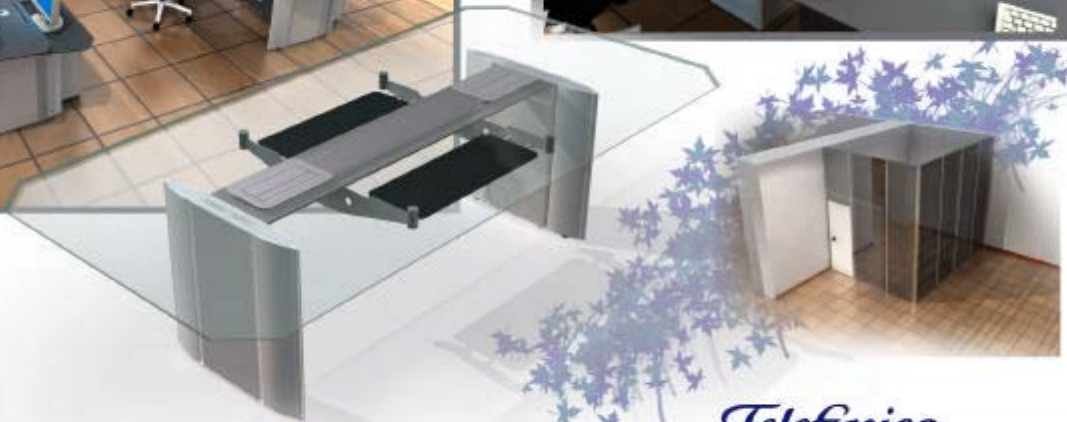

PROYECTO: 030407374bis- FECHA: 24/05/2004

Queda prohibida la reproducción total o parcial de este diseño sin el consentimiento escrito de GESAB S.A.

www.gesabgroup.com · www.gesab.es

 **Gesab**
guarantes for the future

Telefonica
ingenieria de seguridad

scanmagnetics.com

CONFERENCES

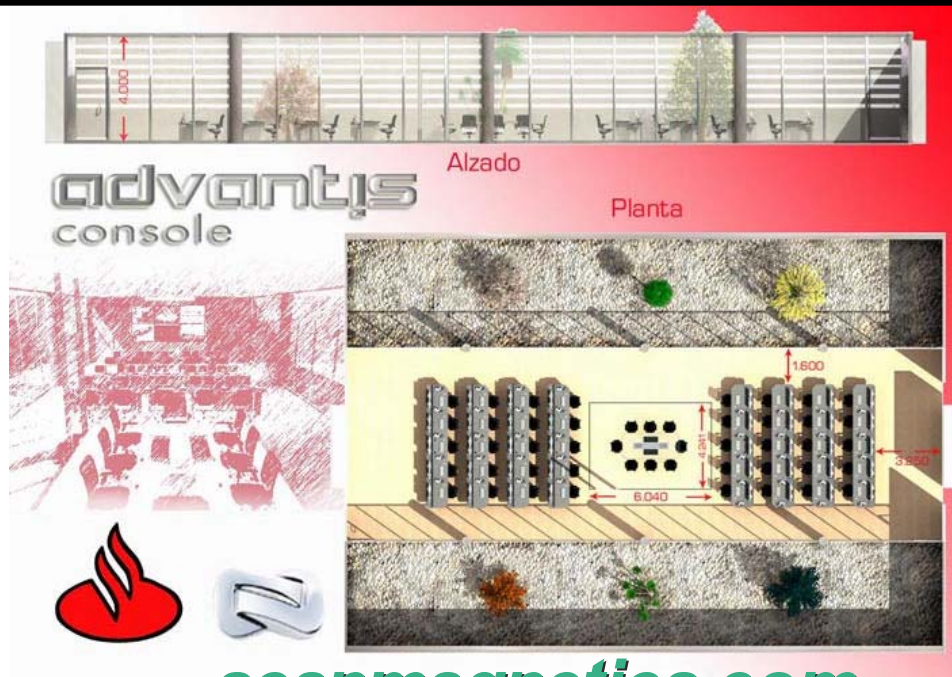

scanmagnetics.com





advantis
console

THANK YOU FOR YOUR TIME & ATTENTION

scanmagnetics.com

 **Gesab**[®]
guarantee for the future